

GREATER EFFICIENCY WITH A SYSTEM

2022

Products and solutions for intra-company material flow.

[ssi-schaefer.com](https://www.ssi-schaefer.com)



SSI SCHÄFER



R 3000 – the multi-functional shelving system

R 3000 is a multi-functional shelving system for small and medium parts storage. The upright frame design and the variable bolt-free system without fixed base and top shelves or longitudinal beams offer a completely flexible design of the shelving bays in 53 mm adjustment steps.

R 3000 eliminates the classical separation of shelves, longspan racking and cantilever racking. This means

one system serves for everything with subsequent expansion options and complete flexibility should your storage needs change.

The fully closed upright profile is designed for attachment of longitudinal beams and cross braces. Pressed-out lugs on the wider side of the upright allow for attachment of shelves. Cut-outs on both sides of the uprights serve for fixing mezzanine supports.

Variable compartment sizes are created by freely positionable shelves and longitudinal beams available for bay widths 994 and 1,282 mm.

Standardized components allow for multi-tier systems that make optimal use of the available ceiling height. Due to its high load-bearing capacity, the R 3000 shelving system is the ideal solution for multi-tier systems with intermediate platforms.



Multi-tier shelving systems



The upright frames are available in different heights for installation of ground level or multi-tier shelving. The frames are pre-assembled on site, stood up and fitted with shelves or beams and cross-braces for stiffening purposes.

The standard platform height is 2,310 mm. This provides enough head room even after installation of sprinkler, air conditioning and lighting installations, etc. The platform height can be adjusted in 53 mm steps.

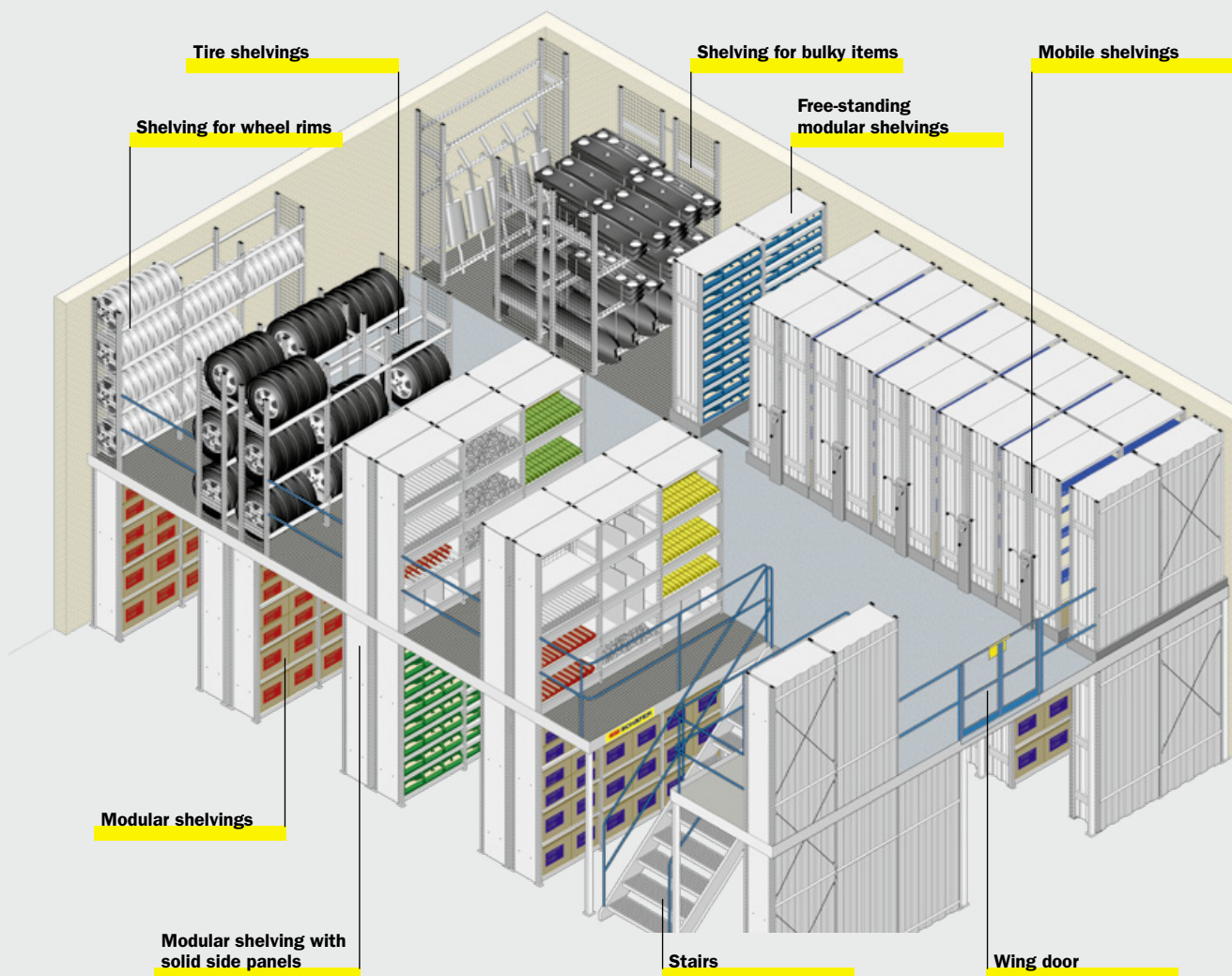

The equipment options

- ▶ **Plug-in design for smooth assembly**
bay widths 994 and 1,282 mm
shelf depths 300, 400, 500, 600, 800 mm
various heights for single and multi-tier installation
- ▶ **Upright profiles**
with 53 mm lug pitch
- ▶ **Frames with slotted uprights**
with slot spacing of 26.5 mm available on request
- ▶ **Fully organized**
thanks to an extensive range of accessories including shelves, beams, shelf dividers, side and back panels, drawers and doors and many more
- ▶ **High loading capacity to 3,500 kg per bay**
- ▶ **Multi-tier installations**
can also be retrofitted

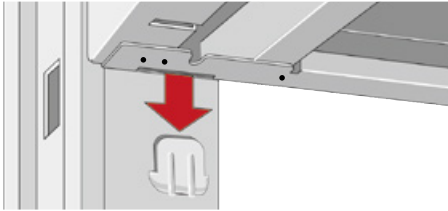

The front edge of the SSI SCHAEFER shelf overlaps the longitudinal edge. In conjunction with the additional welding points, this enhances security and the load-bearing capacity of the shelf.

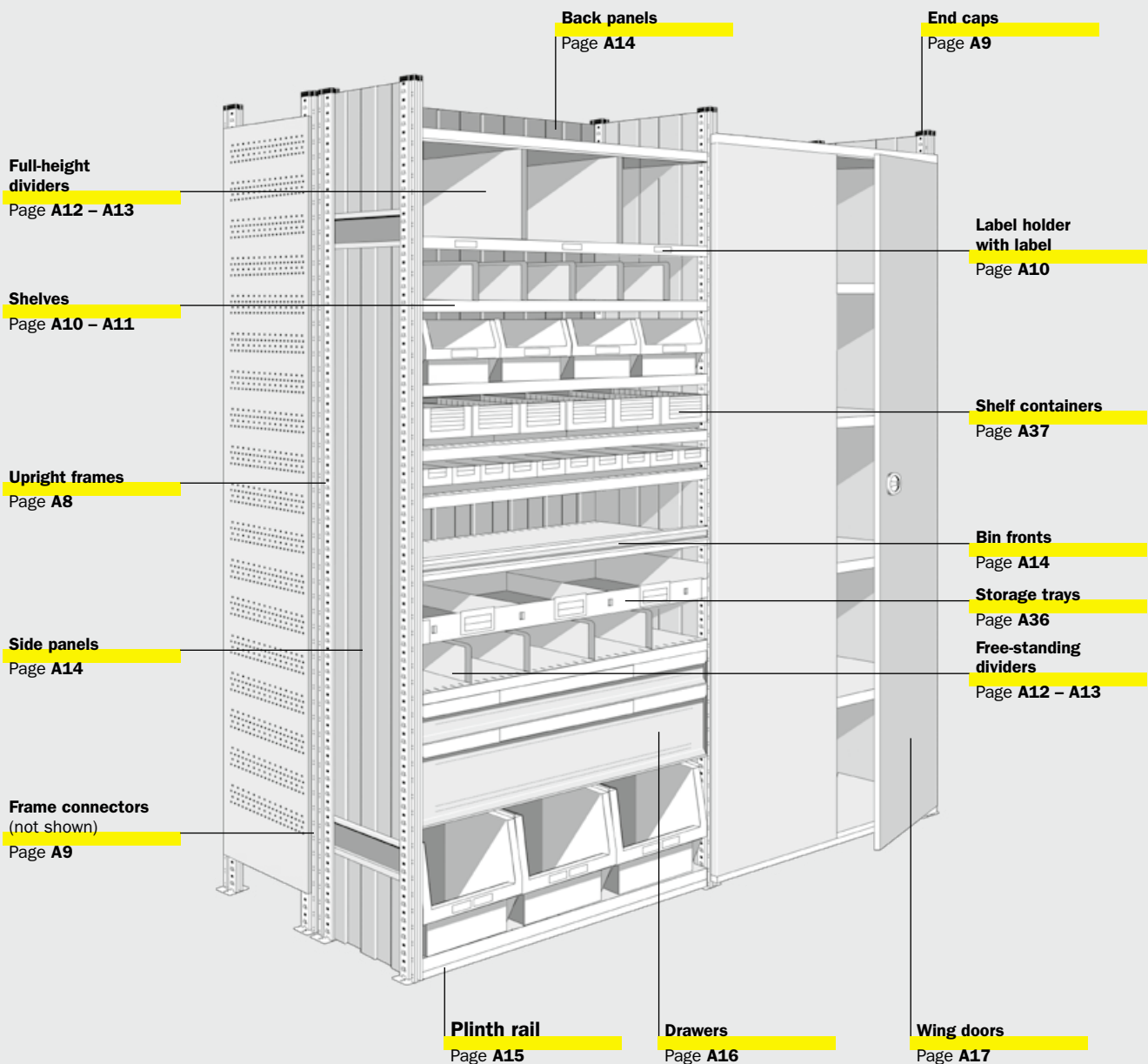

Modular shelving

Longspan racking

Pallet racking

Cantilever racking

On-line shelving / KDR shelving

Customer Service & Support

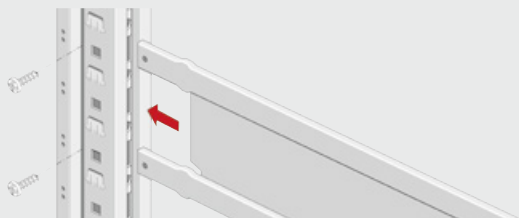

Upright frame system

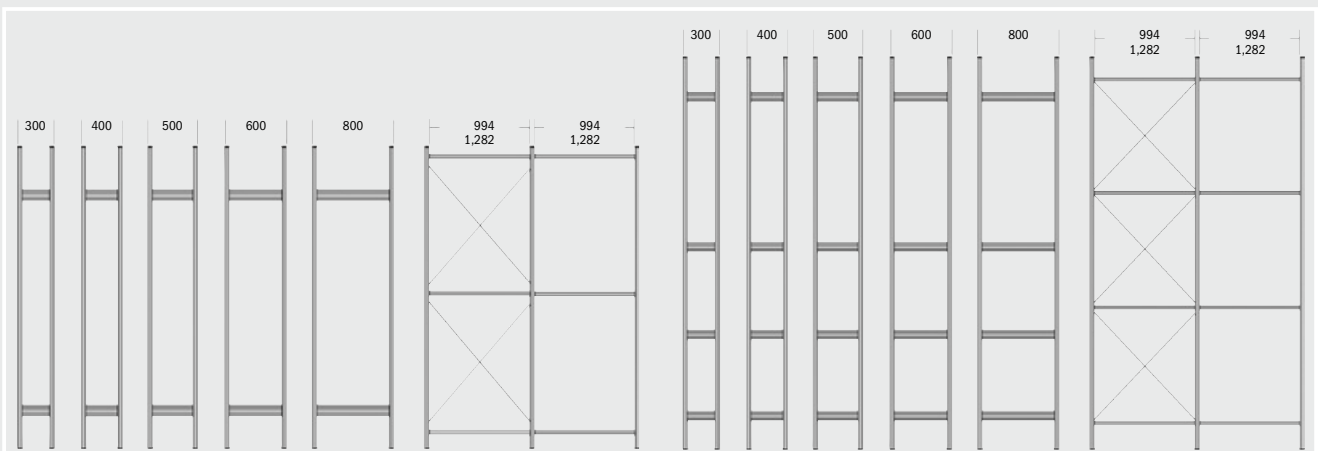

Upright frames for single-tier installation

The loads indicated are approximate values that depend on a variety of parameters.

Item	Shelf depth (mm)	Bay load (kg) for height (mm)		Type	Order no.
		2 x 901	1 x 1,325		
Height 2,278 mm					
RR 33322-V-M	300	1,900	1,500	Galvanized	6671815
RR 34322-V-M	400	1,900	1,500	Galvanized	6671816
RR 35322-V-M	500	1,900	1,500	Galvanized	6671817
RR 36322-V-M	600	1,900	1,500	Galvanized	6671818
RR 38322-V-M	800	1,900	1,500	Galvanized	6671819

Item	Shelf depth (mm)	Bay load (kg) for height (mm)		Type	Order no.
		2 x 901	1 x 1,325		
Height 2,490 mm					
RR 33325-V-M	300	1,800	1,250	Galvanized	6671820
RR 34325-V-M	400	1,800	1,250	Galvanized	6671821
RR 35325-V-M	500	1,800	1,250	Galvanized	6671822
RR 36325-V-M	600	1,800	1,250	Galvanized	6671823
RR 38325-V-M	800	1,800	1,250	Galvanized	6671824

Item	Shelf depth (mm)	Bay load (kg) for height (mm)		Type	Order no.
		3 x 901	2 x 1,325		
Height 2,967 mm					
RR 33330-V-M	300	-	1,500	Galvanized	6671825
RR 34330-V-M	400	-	1,500	Galvanized	6671826
RR 35330-V-M	500	-	1,500	Galvanized	6671827
RR 36330-V-M	600	-	1,500	Galvanized	6671828
RR 38330-V-M	800	-	1,500	Galvanized	6671829

Upright frames for multi-tier installation

The loads indicated are approximate values that depend on a variety of parameters.

Item	Shelf depth (mm)	Bay load (kg)		Type	Order no.
Height 2,278 mm					
RR 33522-V-M	300	3,500		Galvanized	6671830
RR 34522-V-M	400	3,500		Galvanized	6671831
RR 35522-V-M	500	3,500		Galvanized	6671832
RR 36522-V-M	600	3,500		Galvanized	6671833
RR 38522-V-M	800	3,500		Galvanized	6671834

Item	Shelf depth (mm)	Bay load (kg)		Type	Order no.
Height 2,490 mm					
RR 33525-V-M	300	3,500		Galvanized	6671835
RR 34525-V-M	400	3,500		Galvanized	6671836
RR 35525-V-M	500	3,500		Galvanized	6671837
RR 36525-V-M	600	3,500		Galvanized	6671838
RR 38525-V-M	800	3,500		Galvanized	6671839

Item	Shelf depth (mm)	Bay load (kg)		Type	Order no.
Height 2,967 mm					
RR 33530-V-M	300	3,500		Galvanized	6671840
RR 34530-V-M	400	3,500		Galvanized	6671841
RR 35530-V-M	500	3,500		Galvanized	6671842
RR 36530-V-M	600	3,500		Galvanized	6671843
RR 38530-V-M	800	3,500		Galvanized	6671844

Item	Shelf depth (mm)	Bay load (kg)		Type	Order no.
Height 4,557 mm					
RR 33545-V-U	300	3,500		Galvanized	6671891
RR 34545-V-U	400	3,500		Galvanized	6671892
RR 35545-V-U	500	3,500		Galvanized	6671893
RR 36545-V-U	600	3,500		Galvanized	6671894
RR 38545-V-U	800	3,500		Galvanized	6671895

i Heights 6,836 and 9,115 mm on request

Order no. = on stock



Dimensions in mm

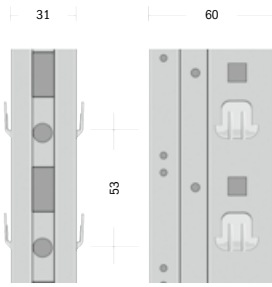

Lug pitch

The continuous lug pattern of the R 3000 upright profile allows for the flexible configuration of the shelving bays with the extensive range of accessories. The compartment heights can be freely adjusted in 53 mm steps by fitting the shelves on the upright lugs.

Shelving components and accessories

Cross braces

A cross brace must be fitted onto the back of the first and every other third rack bay to stabilize the racks.

Note: Shelves must be installed near the cross-brace connecting points.

Item	Bay width (mm)	Height (mm)	Order no.
KV 31009	994	901	6670673
KV 31013		1,325	146000
KV 31309	1,282	901	6670674
KV 31313		1,325	146010

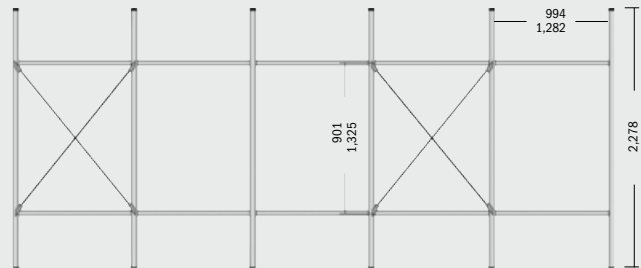

Shim plates

Sheet steel, galvanized. To compensate for slightly uneven ground surfaces.

Item	Thickness (mm)	Order no.
UP3001-V	1	6671710
UP3002-V	2	6671711
UP3003-V	3	6671712

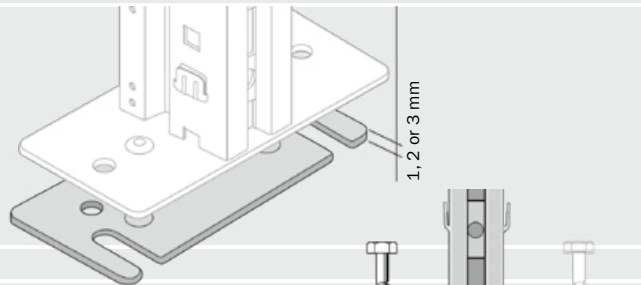

Floor fixing

Screw anchor for anchoring the racks to the floor.

Item	Order no.
HUS3-H6x60	6671728

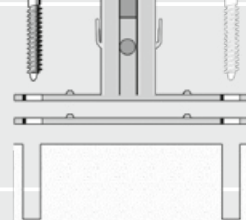

Horizontal braces

Sheet steel, powder-coated light silver. Used for stiffening shelving rows longitudinally when cross-braces cannot be used because single-sided shelving must be accessible from both sides respectively when long parts must be pushed through in a double-sided bay. The frame distance must be at least 30 mm in order to guarantee that the braces can be subsequently adjusted in height. 2 horizontal braces are fitted onto the upper and lower shelf of each rack bay of a rack row (for shelf heights up to 2,967 mm). The interlocking connection with the upright guarantees high rigidity. **Bay load-bearing capacity on request!**

Item	Bay width (mm)	Shelf height (mm)	Order no.
LV 3103	994	30	145060
LV 3133	1,282	30	145070
LV 3104	994	40	145080
LV 3134	1,282	40	145090

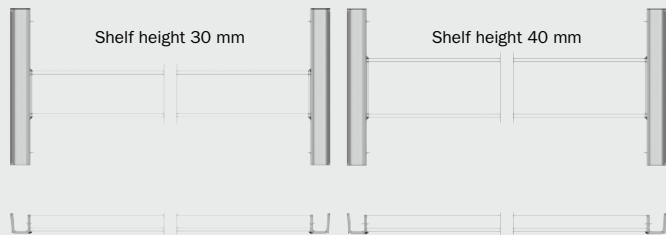

Frame connector

Sheet steel, galvanized. For connecting 2 shelving bays back-to-back in a row. Frame spacing at least 6 mm. Incl. fixing kit.

Item	Frame distance (mm)	Order no.
RV 3006	6	147080
RV 3030	30	147090
RV 3050	50	147100
RV 3100	100	147110
RV 3300	300	147120

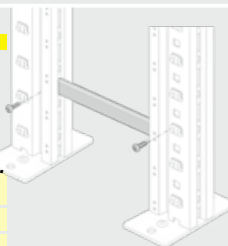

End cap

High-quality black plastic. Attached to the uprights as an end piece.

Item	Order no.
AK 3000	147130



Modular shelving

Longspan racking

Pallet racking

Cantilever racking

On-line shelving/ KDR shelving

Customer Service & Support



GALVANIZED LIGHT SILVER



Shelves

Shelves

Sheet steel, powder-coated light silver or galvanized, 30 or 40 mm high. Used to subdivide a bay into individual compartments with variable heights. Designed with two slot rows at the front and the back side for fitting vertical dividers. Slot spacing 41 mm. Offset arrangements of different compartment heights in a double-sided bay and row are possible

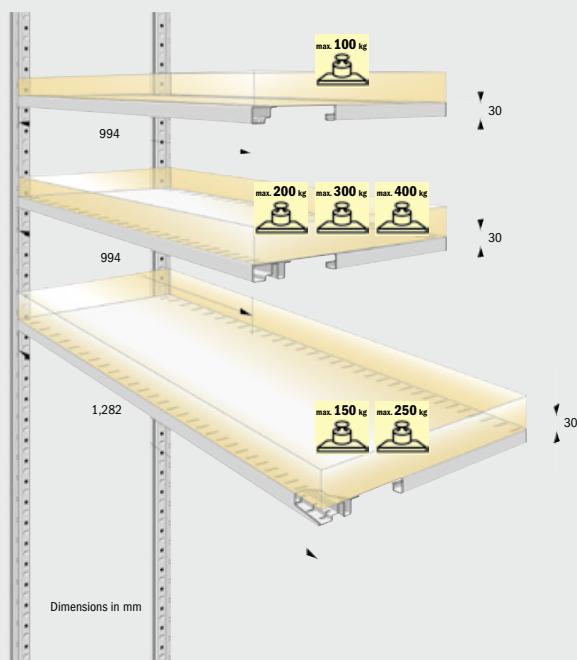
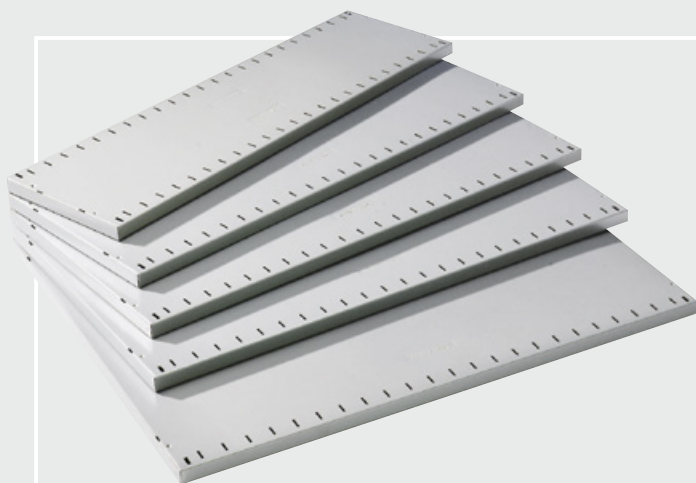

Shelves for bay width 994 mm, height 30 mm

Sheet steel, powder-coated light silver or galvanized.

Item	Shelf depth (mm)	Load capacity max. (kg)	Edge design	Surface	Order no.
ZB 4313 V	300	100	N	Galvanized	27002
ZB 4313 L		100	N	Powder-coated	27000
ZB 4413 V	400	100	N	Galvanized	27012
ZB 4413 L		100	N	Powder-coated	27010
ZB 4423 V		200	V	Galvanized	27022
ZB 4423 L		200	V	Powder-coated	27020
ZB 4513 V	500	100	N	Galvanized	27032
ZB 4513 L		100	N	Powder-coated	27030
ZB 4523 V		200	V	Galvanized	27042
ZB 4523 L		200	V	Powder-coated	27040
ZB 4533 V		300	V	Galvanized	27052
ZB 4533 L		300	V	Powder-coated	27050
ZB 4543 V		400	V	Galvanized	27062
ZB 4543 L		400	V	Powder-coated	27060
ZB 4613 V	600	100	N	Galvanized	27072
ZB 4613 L		100	N	Powder-coated	27070
ZB 4623 V		200	V	Galvanized	27082
ZB 4623 L		200	V	Powder-coated	27080
ZB 4633 V		300	V	Galvanized	27092
ZB 4633 L		300	V	Powder-coated	27090
ZB 4643 V		400	V	Galvanized	27102
ZB 4643 L		400	V	Powder-coated	27100
ZB 4823 V	800	200	V	Galvanized	27172
ZB 4823 L		200	V	Powder-coated	27170
ZB 4843 V		400	V	Galvanized	27192
ZB 4843 L		400	V	Powder-coated	27190

Shelves for bay width 1,282 mm, height 30 mm

Sheet steel, powder-coated light silver or galvanized.

ZB 9415 V	400	150	V	Galvanized	38102
ZB 9415 L		150	V	Powder-coated	38100
ZB 9515 V	500	150	V	Galvanized	38112
ZB 9515 L		150	V	Powder-coated	38110
ZB 9525 V		250	V	Galvanized	38122
ZB 9525 L		250	V	Powder-coated	38120
ZB 9615 V	600	150	V	Galvanized	38132
ZB 9615 L		150	V	Powder-coated	38130
ZB 9625 V		250	V	Galvanized	38142
ZB 9625 L		250	V	Powder-coated	38140
ZB 9825 V	800	250	V	Galvanized	38282
ZB 9825 L		250	V	Powder-coated	38280

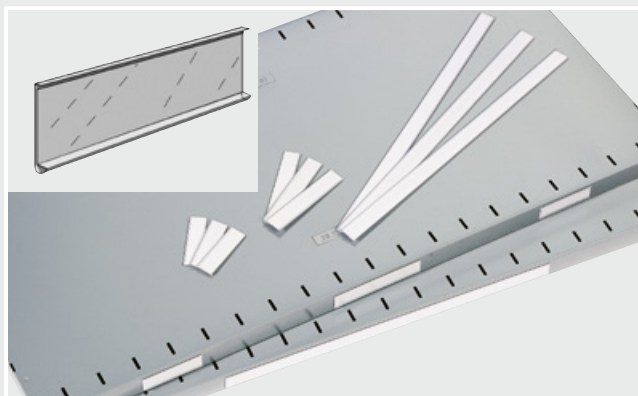

Label holder

Self-adhesive, for labeling storage locations.

Item	Length (mm)	PU	Order no.
EH 4085	85	50	27800
EH 4135	135	50	27810
EH 4490	490	50	27820
EH 4980	980	25	26360
EH 9125	1,250	25	26370

Labels

Item	Length (mm)	PU	Order no.
EHE 4085	85	100	28050
EHE 4135	135	100	28060
EHE 4490	490	100	28070

Order no. = on stock

Shelves

Underside Shelf
V-design

Underside Shelf
N-design

Shelves for bay width 994 mm, height 40 mm

Sheet steel, powder-coated light silver or galvanized.

Item	Shelf depth (mm)	Load capacity max. (kg)	Edge design	Surface	Order no.
ZB 331010 V	300	100	N	Galvanized	145500
ZB 331010 L		100	N	Powder-coated	on req.
ZB 341010 V	400	100	N	Galvanized	145510
ZB 341010 L		100	N	Powder-coated	on req.
ZB 341020 V		200	N	Galvanized	145570
ZB 341020 L		200	N	Powder-coated	on req.
ZB 351010 V	500	100	N	Galvanized	145520
ZB 351010 L		100	N	Powder-coated	on req.
ZB 351020 V		200	N	Galvanized	145580
ZB 351020 L		200	N	Powder-coated	on req.
ZB 351030 V		300	N	Galvanized	145640
ZB 351030 L		300	N	Powder-coated	on req.
ZB 351040 V		400	V	Galvanized	145660
ZB 351040 L		400	V	Powder-coated	on req.
ZB 361010 V	600	100	N	Galvanized	145530
ZB 361010 L		100	N	Powder-coated	on req.
ZB 361020 V		200	N	Galvanized	145590
ZB 361020 L		200	N	Powder-coated	on req.
ZB 361030 V		300	N	Galvanized	145650
ZB 361030 L		300	N	Powder-coated	on req.
ZB 361040 V		400	V	Galvanized	145670
ZB 361040 L		400	V	Powder-coated	on req.
ZB 381020 V	800	200	N	Galvanized	145600
ZB 381020 L		200	N	Powder-coated	on req.
ZB 381040 V		400	V	Galvanized	145680
ZB 381040 L		400	V	Powder-coated	on req.

Shelves for bay width 1,282 mm, height 40 mm

Sheet steel, powder-coated light silver or galvanized.

ZB 341315 V	400	150	N	Galvanized	145540
ZB 341315 L		150	N	Powder-coated	on req.
ZB 351315 V	500	150	N	Galvanized	145550
ZB 351315 L		150	N	Powder-coated	on req.
ZB 351325 V		250	V	Galvanized	145610
ZB 351325 L		250	V	Powder-coated	on req.
ZB 361315 V	600	150	N	Galvanized	145560
ZB 361315 L		150	N	Powder-coated	on req.
ZB 361325 V		250	V	Galvanized	145620
ZB 361325 L		250	V	Powder-coated	on req.
ZB 381325 V	800	250	V	Galvanized	145630
ZB 381325 L		250	V	Powder-coated	on req.

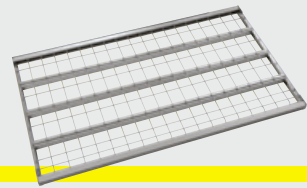

i Wire mesh shelves

page A21

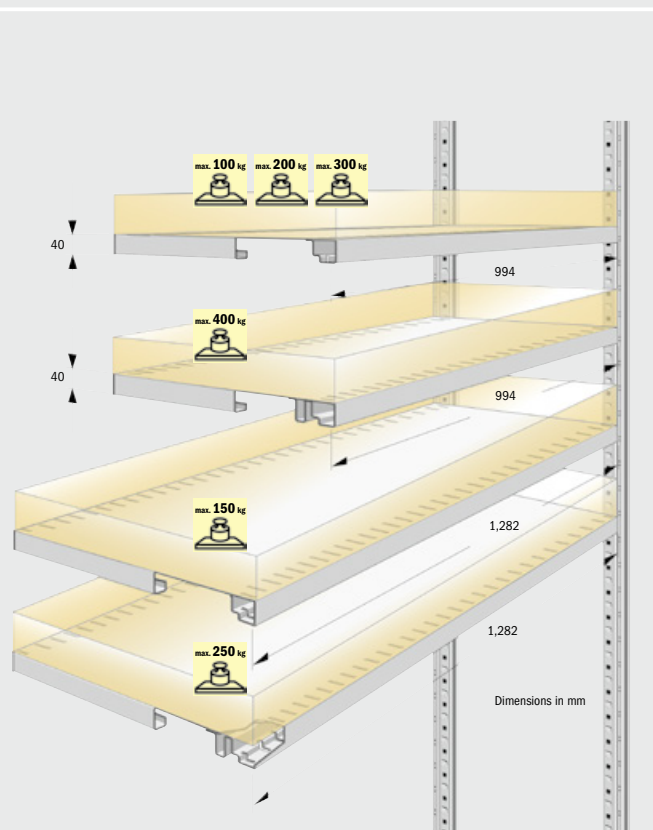

i Shelf containers for modular shelvings

from page A37

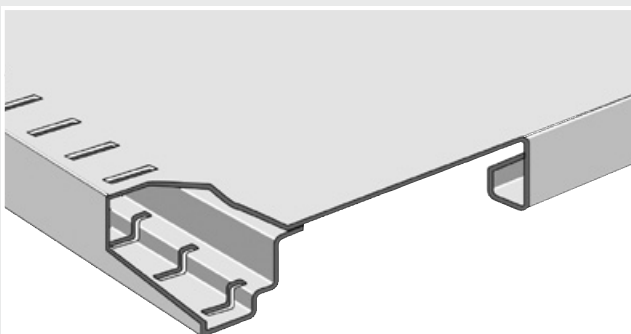

Single edge shelf with 6-fold longitudinal edge = N-design

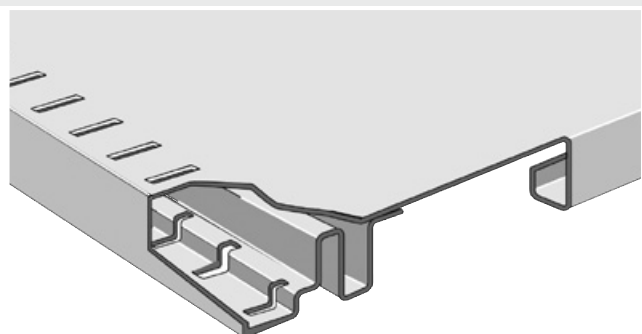

Double edge shelf with 10-fold longitudinal edge = V-design



Vertical shelf dividers

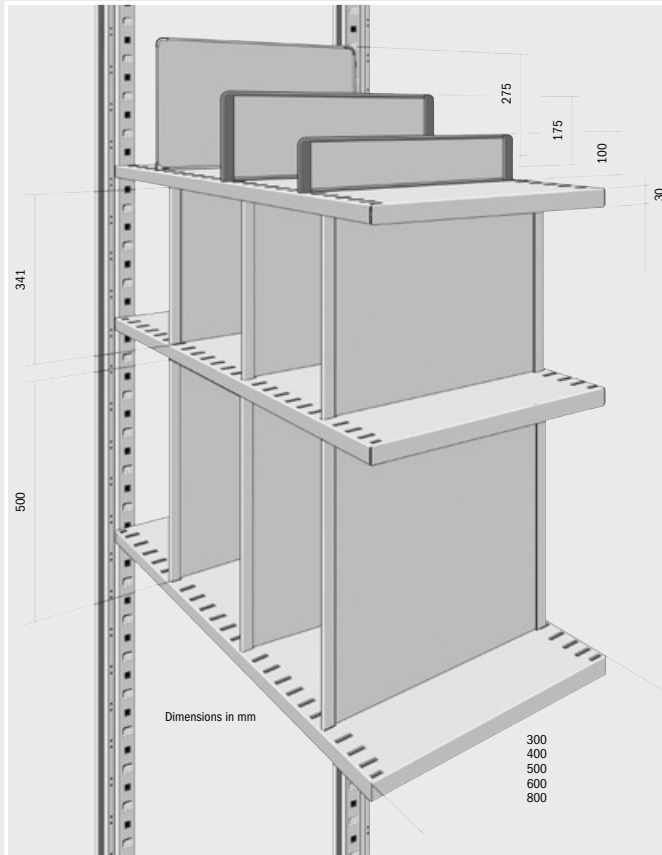

Free-standing dividers for 30 mm high shelves

Sheet steel, galvanized. These dividers are inserted into the slots of the shelves independently of the compartment height and can also be used in combination with big fronts.

Item	Shelf depth (mm)	Divider height (mm)	Version with	Order no.
TRF-K 4310	300	100	Plastic connectors	27300
TRF-K 4317		175	Plastic connectors	27340
TRF-K 4410	400	100	Plastic connectors	27310
TRF-K 4417		175	Plastic connectors	27350
TRF-D 4427		275	Wire connectors	27380
TRF-K 4510	500	100	Plastic connectors	27320
TRF-K 4517		175	Plastic connectors	27360
TRF-D 4527		275	Wire connectors	27390
TRF-K 4610	600	100	Plastic connectors	27330
TRF-K 4617		175	Plastic connectors	27370
TRF-D 4627		275	Wire connectors	27400
TRF-D 4810	800	100	Wire connectors	39650
TRF-D 4817		175	Wire connectors	39660

Full-height dividers

Sheet steel, galvanized, for clear shelf heights of 341 mm and 500 mm.

Item	Shelf depth (mm)	Shelf height (mm)	Order no.
TR 4340	300	341	27200
TR 4440	400	341	27210
TR 4450		500	27240
TR 4540	500	341	27220
TR 4550		500	27250
TR 4640	600	341	27230
TR 4650		500	27260

Height elevations using shelves for the shelving heights 2,278, 2,490 and 2,967 mm

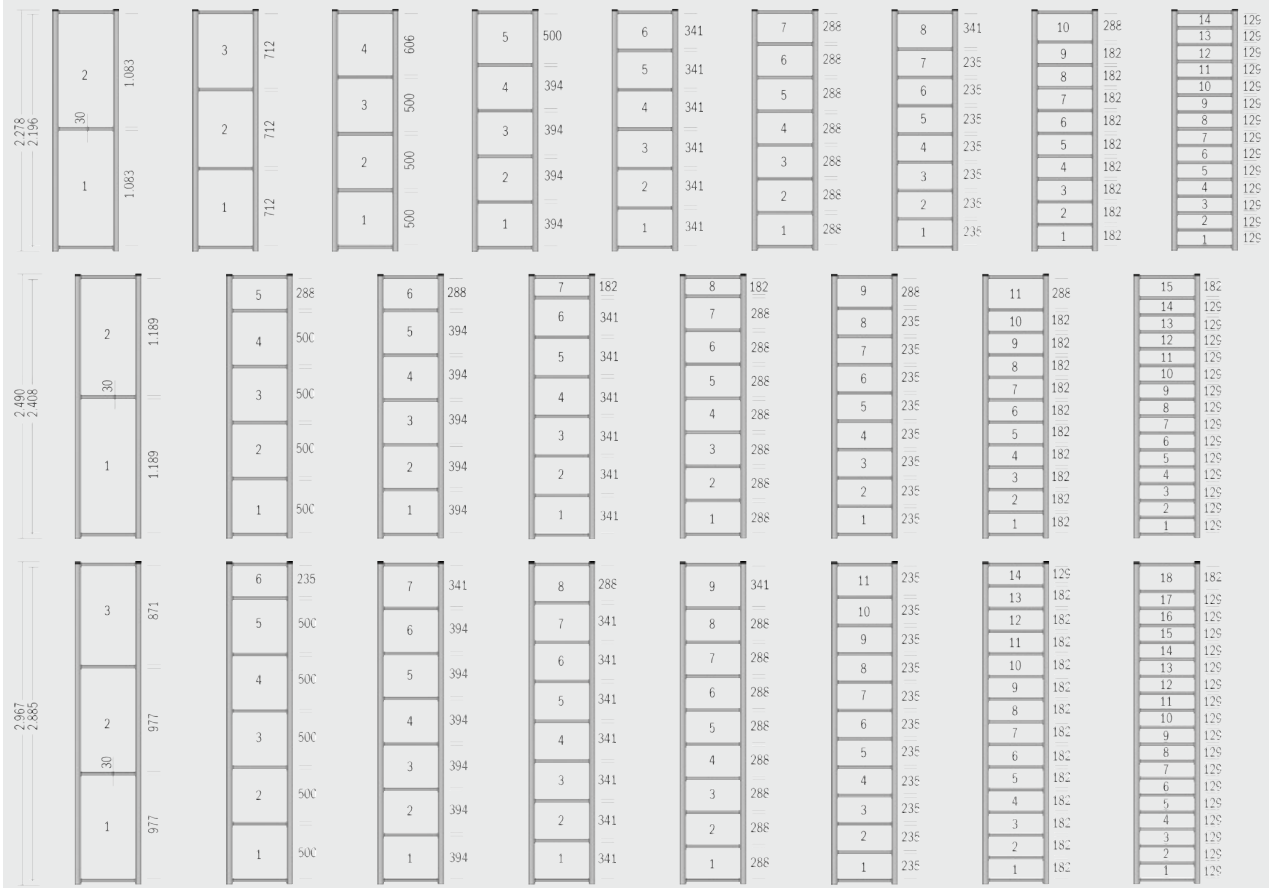

Order no. = on stock

Vertical shelf dividers

Free-standing dividers for 40 mm high shelves

Sheet steel, galvanized. These dividers are inserted into the slots of the shelves independently of the compartment height and can also be used in combination with big fronts.

Item	Shelf depth (mm)	Divider height (mm)	Version with	Order no.
TRF-K 4310 G	300	100	Plastic connectors	27301
TRF-K 4317 G		175	Plastic connectors	27341
TRF-K 4410 G	400	100	Plastic connectors	27311
TRF-K 4417 G		175	Plastic connectors	27351
TRF-D 4427 G		275	Wire connectors	27381
TRF-K 4510 G	500	100	Plastic connectors	27321
TRF-K 4517 G		175	Plastic connectors	27361
TRF-D 4527 G		275	Wire connectors	27391
TRF-K 4610 G	600	100	Plastic connectors	27331
TRF-K 4617 G		175	Plastic connectors	27371
TRF-D 4627 G		275	Wire connectors	27401
TRF-D 4810 G	800	100	Wire connectors	39651
TRF-D 4817 G		175	Wire connectors	39661

Full-height dividers

Sheet steel, galvanized, for clear shelf heights of 331 mm and 490 mm.

TR 3330	300	331	147000
TR 3430	400	331	147010
TR 3450		490	147020
TR 3530	500	331	147030
TR 3550		490	147040
TR 3630	600	331	147050
TR 3650		490	147060

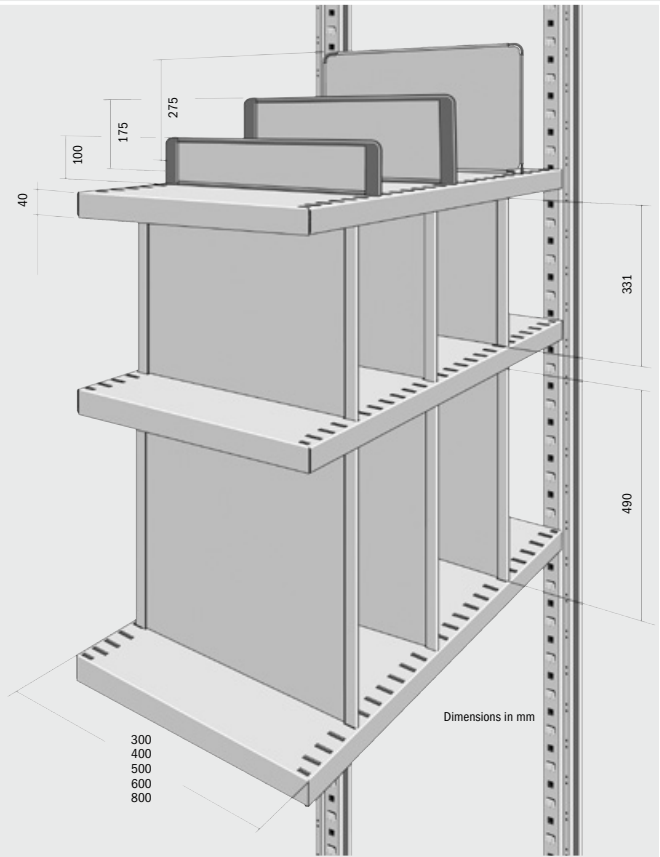

Height elevations using shelves for the shelving heights 2,278, 2,490 and 2,967 mm

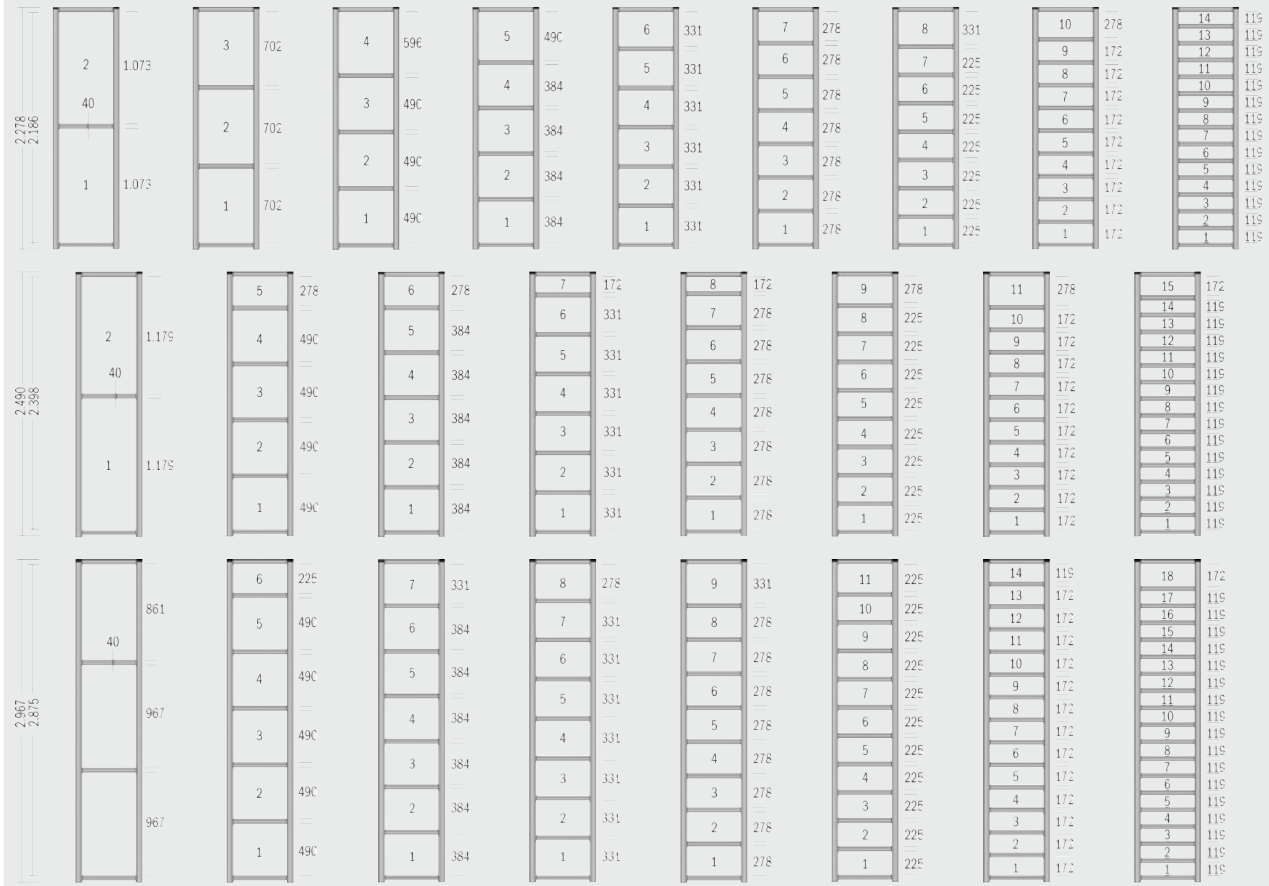

Modular shelving

Longspan racking

Pallet racking

Cantilever racking

On-line shelving/ KDR shelving

Customer Service & Support

Shelving components and accessories

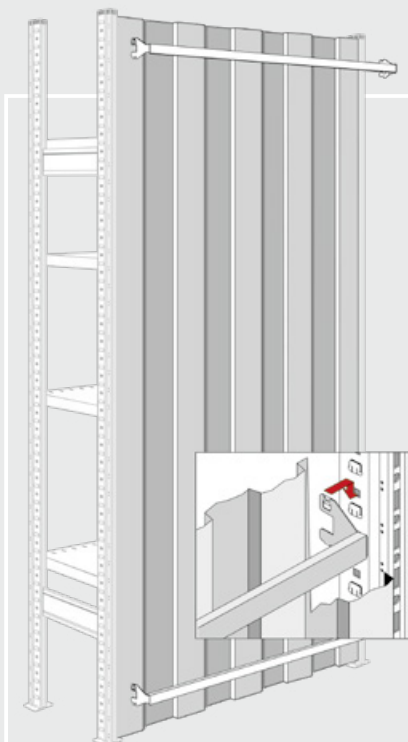

Back panels

Sheet steel, galvanized. The 3-piece back panel leans against the shelves. The retaining beams are installed behind the back panel and attached to the upright lugs.

For bay width 994 mm, 3-piece

Item	Height (mm)	Order no.
RWA 31022	2,278	146700
RWA 31025	2,490	146520
RWA 31030	2,967	146530

For bay width 1,282 mm, 3-piece

RWA 31322	2,278	146710
RWA 31325	2,490	146550
RWA 31330	2,967	146560

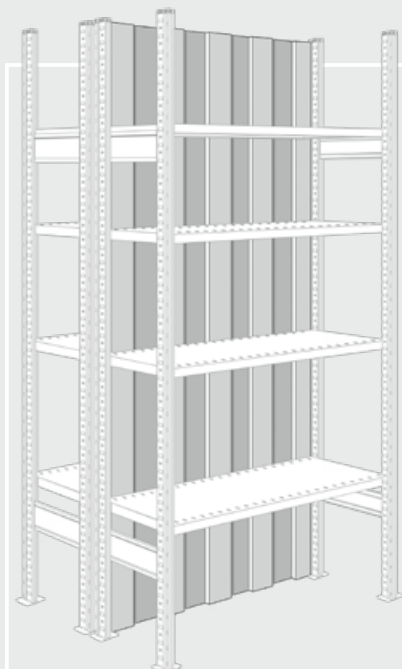

Center panels, inside

Sheet steel, galvanized. Installed in double-sided bays. The panels are held in position by the shelves.

For bay width 994 mm, 3-piece

Item	Height (mm)	Order no.
RWI 31022-V	2,278	6672470
RWI 31025-V	2,490	6672471
RWI 31030-V	2,967	6672472

For bay width 1,282 mm, 3-piece

RWI 31322-V	2,278	6672473
RWI 31325-V	2,490	6672474
RWI 31330-V	2,967	6672475

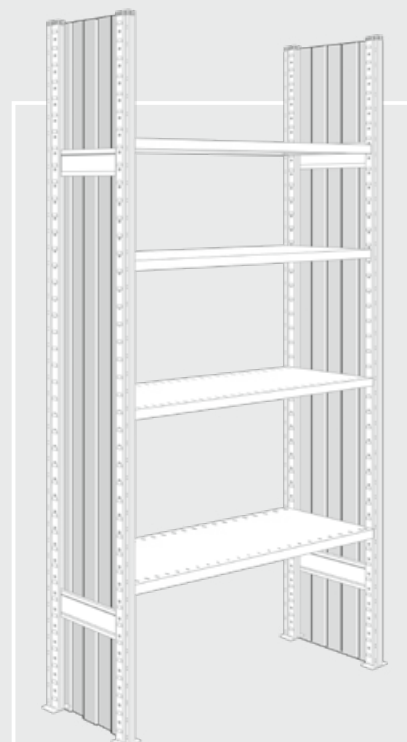

Side panels

Sheet steel, galvanized. The side panel leans against the upright frame and is held in position by the shelves.

For height 2,278 mm

Item	Shelf depth (mm)	Order no.
SWI 3322-V	300	6672395
SWI 3422-V	400	6672399
SWI 3522-V	500	6672402
SWI 3622-V	600	6672405
SWI 3822-V	800	6672408

For height 2,490 mm

SWI 3325-V	300	6672396
SWI 3425-V	400	6672400
SWI 3525-V	500	6672403
SWI 3625-V	600	6672406
SWI 3825-V	800	6672409

For height 2,967 mm

SWI 3330-V	300	6672397
SWI 3430-V	400	6672401
SWI 3530-V	500	6672404
SWI 3630-V	600	6672407
SWI 3830-V	800	6672410

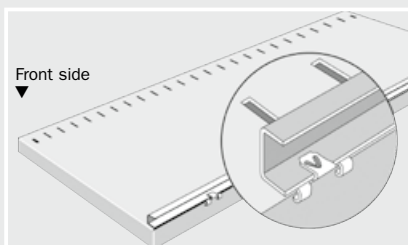

Back stop

Sheet steel, galvanized. Prevents load carriers and storage goods from being pushed through, include 3 clips.

Item	Bay width (mm)	Order no.
DSL 4102	994	27990
DSL 9131	1,282	38190

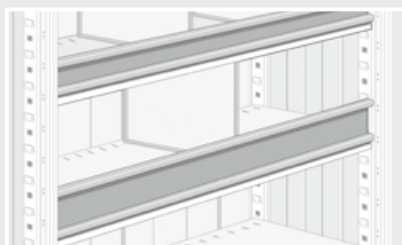

Bin fronts

Sheet steel, galvanized, for storing loose small parts. Particularly useful in conjunction with dividers and side and back panels.

Item	Bay width (mm)	Strip height (mm)	Order no.
VL 4001	994	40	27760
VL 4000		85	27750
VL 9001	1,282	40	37850
VL 9000		85	37860

U-profile strips

We recommend U-profile strips when using sheet steel central and back panels (RWI/RWA type).

U-profile strips, single

As an installation aid at the bottom or as a top piece.

Item	for bay width (mm)	Order no.
RWUE 3100	994	6623182
RWUE 3130	1,282	6623184

Order no. = on stock

Accessories

GALVANIZED LIGHT SILVER

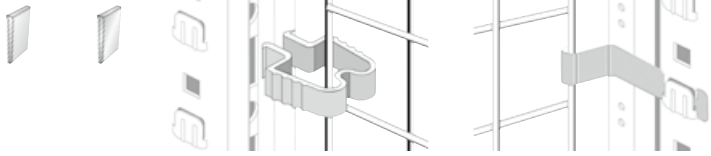

Mesh side panel fastening

Mesh back panel fastening

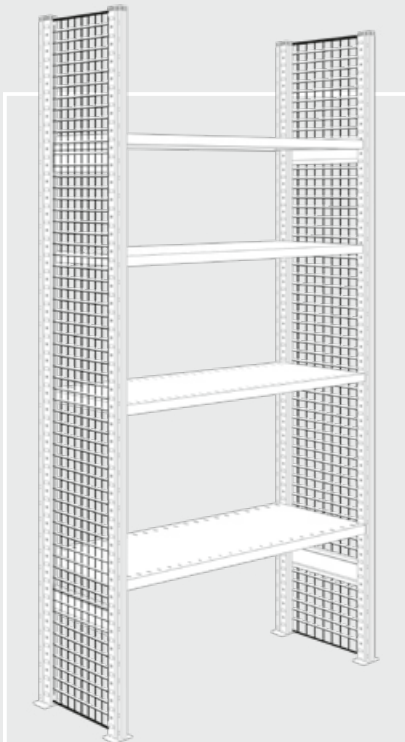

Mesh side panels

Steel wire, painted light silver. The panels are attached to the uprights using clips. Incl. fixing kit.

For height 2,278 mm

Item	Shelf depth (mm)	Order no.
SWG 3322	300	146740
SWG 3422	400	146750
SWG 3522	500	146760
SWG 3622	600	146770
SWG 3822	800	146780

For height 2,490 mm

SWG 3325	300	146350
SWG 3425	400	146360
SWG 3525	500	146370
SWG 3625	600	146380
SWG 3825	800	146390

For height 2,967 mm, 2-piece

SWG 3330	300	146400
SWG 3430	400	146410
SWG 3530	500	146420
SWG 3630	600	146430
SWG 3830	800	146440

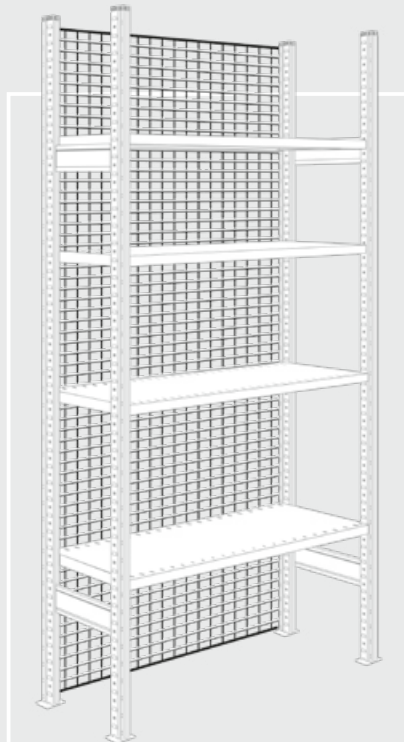

Mesh back panels

Steel wire, painted light silver. The panels are attached to the uprights using retaining springs. Incl. fixing kit.

For bay width 994 mm

Item	Height (mm)	Order no.
RWG 31022	2,278	146790
RWG 31025	2,490	146580
RWG 31030	2,967/pair	146590

For bay width 1,282 mm

RWG 31322	2,278	146800
RWG 31325	2,490	146610
RWG 31330	2,967/pair	146620



Angled version

Straight version

Aisle signage

For longitudinal and lateral labeling, with transparent film and removable labels. 1 PU = 10 pieces

Item	Type	Order no.
GBQ	straight version	145720
GBL	angled version	145730

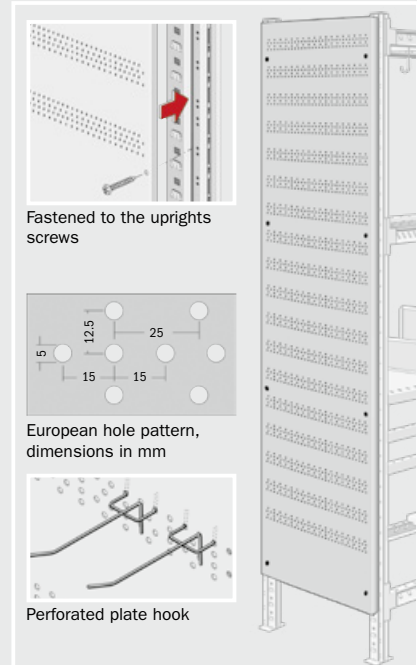

Fastened to the uprights screws

European hole pattern, dimensions in mm

Perforated plate hook

Outer side panels, perforated

Sheet steel, galvanized. Incl. fixing kit.

Height 2,000 mm

Item	Shelf depth (mm)	Order no.
SWA 3420	400	146260
SWA 3520	500	146270
SWA 3620	600	146280

Perforated plate hook

LPH 100		26790
---------	--	-------

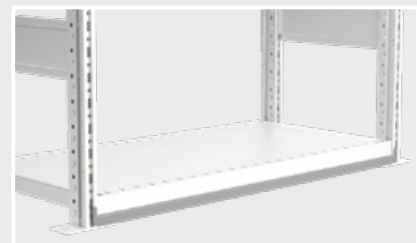

Plinth rails

Sheet steel, galvanized. Covers the space between the shelf fitted onto the first cam and the floor.

Item	Bay width (mm)	Order no.
SO 3100-V	994	6672450
SO 3130-V	1,282	6672451

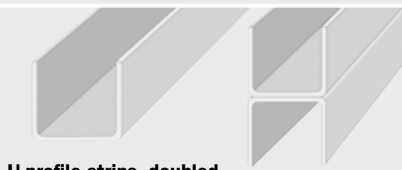

U-profile strips, doubled

As a connecting element for panel elements above each other. Suitable for RWA/RWI.

Item	for bay width (mm)	Order no.
RWUD 3100	994	6623180
RWUD 3130	1,282	6623181

Modular shelving

Longspan racking

Pallet racking

Cantilever racking

On-line shelving/ KDR shelving

Customer Service & Support

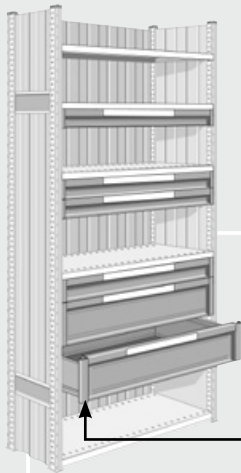

Drawers and accessories

Stability

According to the guidelines of the German DG-UV rule 108-007, it is necessary to secure shelving units against tilting when drawers without a mechanical locking system are used.

Lateral drawer linings with and without lock

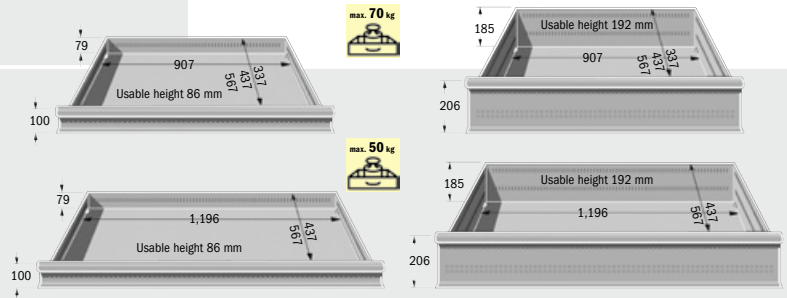

Lateral drawer linings

Sheet steel, galvanized or painted light silver. Used to cover the space between the shelving uprights and the drawers. Installation by means of cross-head screws on the left and on the right hand side of the drawer faceplates.

Supplied as a complete set for one drawer each.

Item	for faceplate height (mm)	Version	Surface	Order no.
SBL-3100-V-Z	100	without lock	galvanized	6672372
SBL-3100-HS-Z		without lock	painted	6672373
SBL-3100-S-V-Z		with lock	galvanized	6672377
SBL-3100-S-HS-Z		with lock	painted	6672378
SBL-3200-V-Z	206	without lock	galvanized	6672375
SBL-3200-HS-Z		without lock	painted	6672376
SBL-3200-S-V-Z		with lock	galvanized	6672380
SBL-3200-S-HS-Z		with lock	painted	6672381

Drawers for bay width 994/1,282 mm

Sheet steel, galvanized, optionally drawer fronts painted light silver. Drawers can be combined with two-wing doors.

Item	Faceplate height (mm)	for bay width (mm)	for shelf depth (mm)	Usable depth (mm)	Load max. (kg)	Order no.
ESCH 341010-V-Z	100	994	400	337	70	6672340
ESCH 351010-V-Z		994	500	437	70	6672342
ESCH 361010-V-Z		994	600	567	70	6672345
ESCH 341310-V-Z		1,282	400	337	50	6672347
ESCH 351310-V-Z		1,282	500	437	50	6672349
ESCH 361310-V-Z		1,282	600	567	50	6672351
ESCH 341020-V-Z	206	994	400	337	70	6672353
ESCH 351020-V-Z		994	500	437	70	6672355
ESCH 361020-V-Z		994	600	567	70	6672357
ESCH 341320-V-Z		1,282	400	437	50	6672359
ESCH 351320-V-Z		1,282	500	437	50	6672361
ESCH 361320-V-Z		1,282	600	567	50	6672363

Drawer dividers and cross partitioning

Pushed into plastic brackets connected to the rows of holes for the drawer front and side panels. For compartment widths 451, 225 and 112 mm, the compartment depths can be freely configured using adjustable cross dividers. Without cross dividers, the full drawer depth can be used, enabling individual compartment lengths.

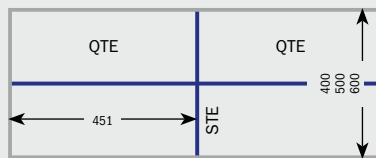

Quarter division, 1x STE and 2x QTE

Item	for drawer	Order no.
SE 4121	ESCH 341010	29742
SE 4122	ESCH 341020	29752
SE 5121	ESCH 351010	29740
SE 5122	ESCH 351020	29750
SE 6121	ESCH 361010	29741
SE 6122	ESCH 361020	29751

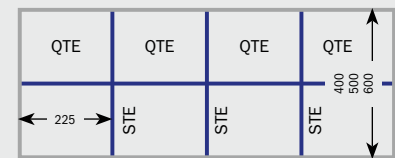

Eighth division, 3x STE and 4x QTE

Item	for drawer	Order no.
SE 4141	ESCH 341010	29762
SE 4142	ESCH 341020	29772
SE 5141	ESCH 351010	29760
SE 5142	ESCH 351020	29770
SE 6141	ESCH 361010	29761
SE 6142	ESCH 361020	29771

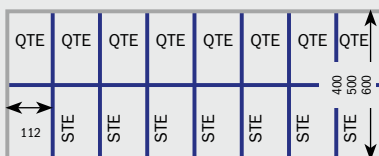

Sixteenth division, 7x STE and 8x QTE

Item	for drawer	Order no.
SE 4181	ESCH 4410	29782
SE 4182	ESCH 4420	29792
SE 5181	ESCH 4510	29780
SE 5182	ESCH 4520	29790
SE 6181	ESCH 4610	29781
SE 6182	ESCH 4620	29791

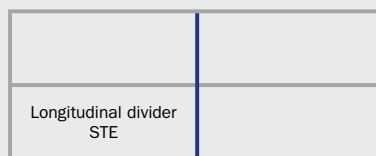

Longitudinal dividers

Item	Drawer front height (mm)	Order no.
STE 4010	100	26660
STE 4020	206	26670
STE 5010	100	29880
STE 5020	206	29881
STE 6010	100	29882
STE 6020	206	29883
QTE/STE	Divider holder	6000349

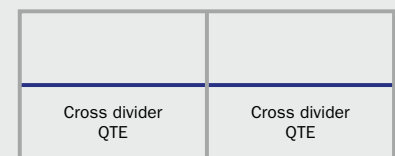

Cross dividers

Item	Division	Drawer front height (mm)	Order no.
QTE 1210	1/2	100	29860
QTE 1220	1/2	206	29861
QTE 1410	1/4	100	29862
QTE 1420	1/4	206	29863
QTE 1810	1/8	100	29864
QTE 1820	1/8	206	29865

Order no. = on stock

BLUE LIGHT SILVER



Pull-out shelves
Wing doors

Two-wing doors

The bottom shelf must always be 30 mm high. The side and back panels must be ordered separately when retrofitting

Pull-out shelves, drawer dividers and wing doors

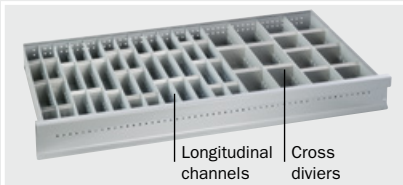

Combination A

12 longitudinal channels W 46.5 mm and 30 cross dividers; 4 longitudinal channels W 93 mm and 10 cross dividers.

Item	Shelving depth (mm)	Order no.
SU-3410-A	400	6672427
SU-3510-A	500	6672430
SU-3610-A	600	6672433



Combination B

6 longitudinal channels W 46.5 mm and 24 cross dividers; 3 longitudinal channels W 93 mm and 12 cross dividers; 2 longitudinal channels W 186 mm and 4 cross dividers.

Item	Shelving depth (mm)	Order no.
SU-3410-B	400	6672428
SU-3510-B	500	6672431
SU-3610-B	600	6672434



Combination C

10 longitudinal channels W 93 mm and 20 cross dividers.

Item	Shelving depth (mm)	Order no.
SU-3410-C	400	6672429
SU-3510-C	500	6672432
SU-3610-C	600	6672435



Insert boxes

Polystyrene, blue, with labeling handle. Pieces per unit: EK 1: 58 pcs.; EK 2: 80 pcs.; EK 3: 120 pcs.; EK 111-N: 48 pcs.

Item	L x W x H (mm)	Order no.
EK 1	180 x 96 x 60	1134
EK 2	90 x 96 x 60	1144
EK 3	90 x 48 x 60	1154
EK 111-N	137 x 87 x 96	4364

Insert boxes – complete set

Only for drawer ESCH 4510. 10x EK 1, 20x EK 2, 10x EK 3.

SET 2501	12914
----------	-------

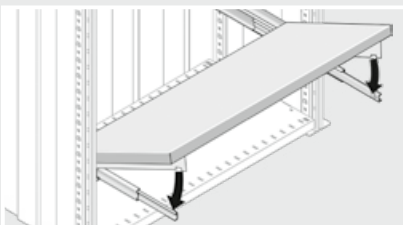

Pull-out shelves

Sheet steel, painted light silver. Complete set including accessories. Compartment load: 70 kg (bay width 994 mm) and 50 kg (bay width 1,282 mm).

Item	Shelf depth (mm)	Bay width (mm)	Order no.
AZB 40995	400	994	35800
AZB 41283		1,282	35810
AZB 50995	500	994	35910
AZB 51283		1,282	35930
AZB 60995	600	994	35920
AZB 61283		1,282	35940

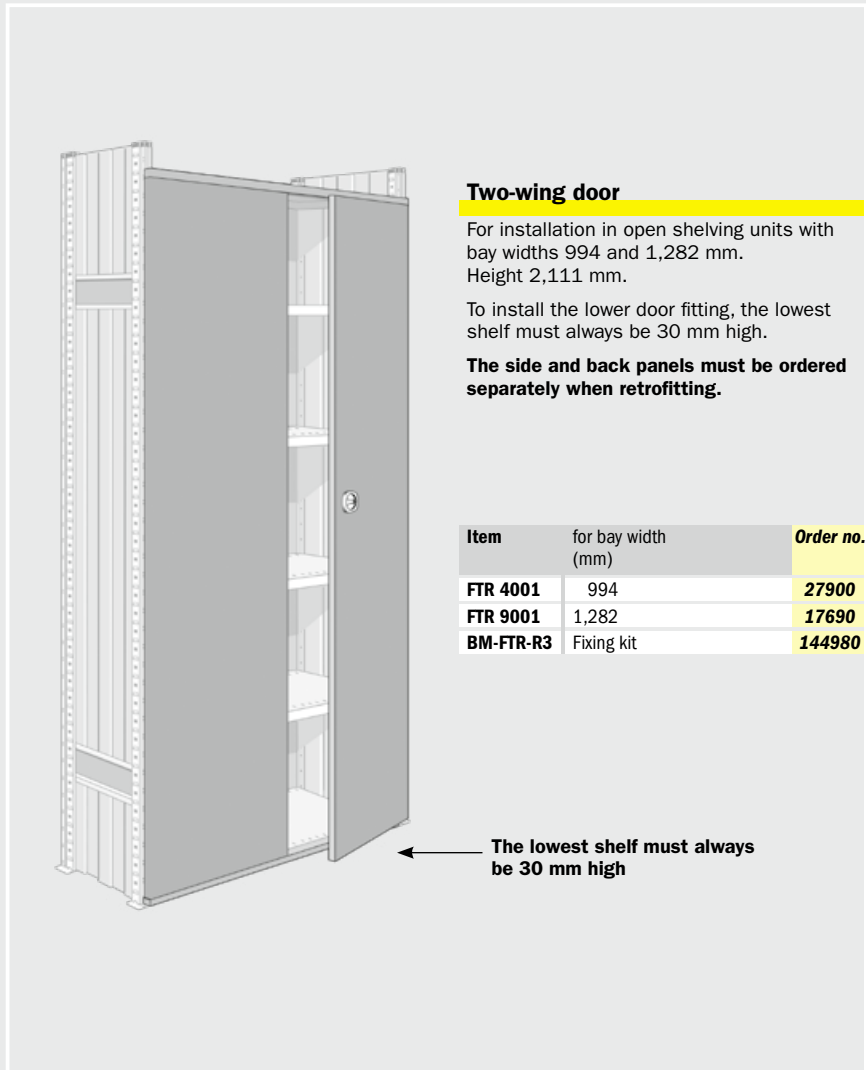

Two-wing door

For installation in open shelving units with bay widths 994 and 1,282 mm. Height 2,111 mm.

To install the lower door fitting, the lowest shelf must always be 30 mm high.

The side and back panels must be ordered separately when retrofitting.

Item	for bay width (mm)	Order no.
FTR 4001	994	27900
FTR 9001	1,282	17690
BM-FTR-R3	Fixing kit	144980

i Side and back panels

page A14

i Additional shelves

from page A10

Modular shelving

Longspan racking

Pallet racking

Cantilever racking

On-line shelving/ KDR shelving

Customer Service & Support



Beams
Tube dividers
Push-in holder

Hanging rail set
Rail support
Bridging cross beam

Accessories for storage of bulky parts

► Longitudinal z-beams

are used for storage of bulky and car body parts. A minimum of two pairs of beams must be installed per bay and secured against being lifted out using the included screws. Shelving with z-beams do not require cross-braces for stiffening purposes.

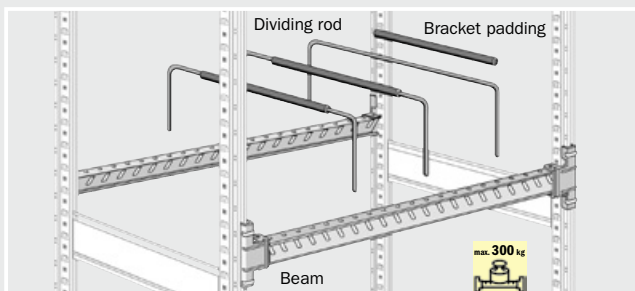

Beams

Sheet steel, galvanized. The height positions of the longitudinal beams can be adjusted in 53 mm steps. Incl. anti-lifting device.

Item	Beam length (mm)	Load/pair max. (kg)	Order no.
KTRZ 31036	994	300	147140
KTRZ 31336	1,282	300	147150
KTRZ 32036	2,019	300	147160

Hoop dividers

The KTB dividers serve to divide 500 or 800 mm deep shelving bays lengthwise. Height 330 mm.

Item	Frame depth (mm)	Order no.
KTB 50	500	159420
KTB 80	800	159430
KTB S	Bracket padding	39640

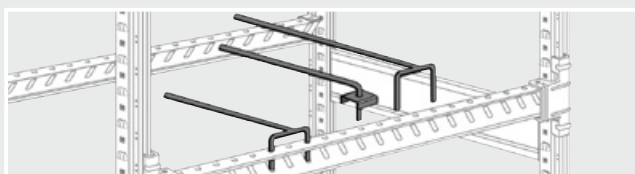

Compartment dividers

Can be inserted and exhaust into the holes in the beams.

Item	Usable length (mm)	for shelf depth (mm)	Version with	Order no.
APH 340 E	340	400	1 connector	18130
APH 340	340	400	2 connectors	18120
APH 740	740	800	2 connectors	18110

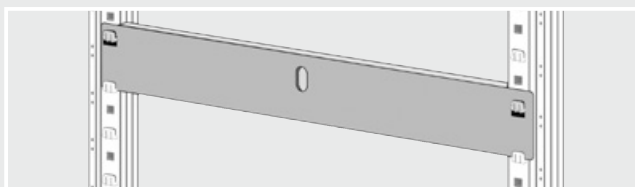

Rail support

Sheet steel, galvanized. For lateral parts support.

Item	For shelf depth (mm)	Order no.
AL 3400	400	147470
AL 3500	500	147770
AL 3600	600	147780
AL 3800	800	147210

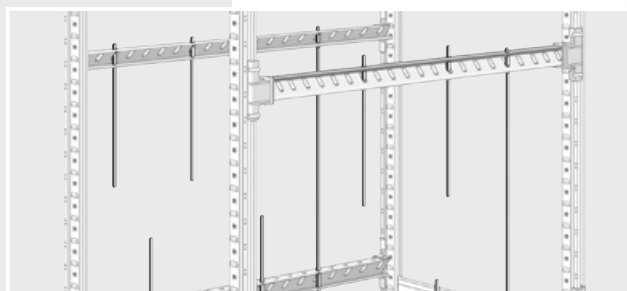

Tube dividers

Sheet steel, galvanized. The tubes are pushed through the holes in the beams and lock in place automatically.

Item	Push-in tube length (mm)	Usable height (mm)	Order no.
KRA 4170	170		159440
KRA 4300	300		159450
KRA 4950	Glass parts holder	894	159460
KRA 4105	Glass parts holder	1,000	159470

Terodaem protective underlay (not shown)

To be stuck on the beams as a protection for sensitive metal parts. Self-adhesive, 932 mm length, 2 mm thick.

Item	Designation	Order no.
KRT 3102	Terodaem underlay, perforated	147340

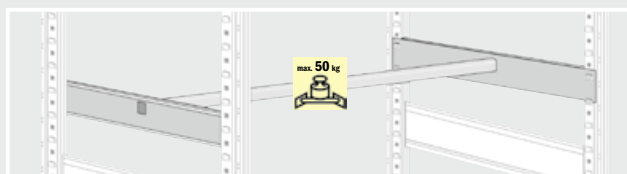

Clothes rail set

Sheet steel, galvanized. For hanging covers, foot mats, clothing, etc.

Item	L x D (mm)	Order no.
KST 3108	994 x 800	147190
KST 3134	1,282 x 400	147490
KST 3138	1,282 x 800	147200

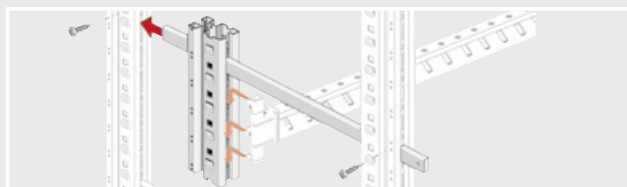

Bridging cross beam

Galvanized, for use in shelving frames and bridge fields as a storage option for differently-shaped parts.

Item	For shelf depth (mm)	Order no.
TRB 3812	800	147170

Order no. = on stock

Accessories for storage of bulky parts

Chipboard shelves, flush with beams

Made of 19 mm high chipboard. They are placed on the longitudinal beams via the universal carrier and create a unit with the same height. At the same time, the 19 mm high longitudinal edge of the wooden shelf is protected.

The beams are not included in the scope of delivery, please order separately (page A18).

Item	shelf depth (mm)	W x D x H (mm)	Order no.
for bay width 994 mm incl. 2 universal carrier			
KRHH 341020	400	985 x 317 x 19	6670428
KRHH 351020	500	985 x 417 x 19	6670429
KRHH 361020	600	985 x 517 x 19	6670430
KRHH 381020	800	985 x 717 x 19	94760
for bay width 1,282 mm incl. 3 universal carrier			
KRHH 341320	400	1,273 x 317 x 19	6670431
KRHH 351320	500	1,273 x 417 x 19	6670432
KRHH 361320	600	1,273 x 517 x 19	6670433
KRHH 381320	800	1,273 x 717 x 19	94670

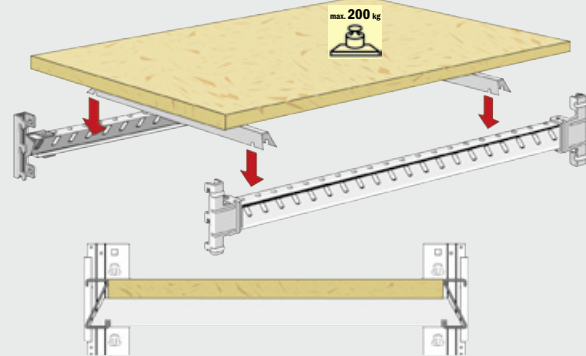

Universal carrier, single

Item	shelf depth (mm)	Order no.
UT 8400	400	6670420
UT 8500	500	6670422
UT 8600	600	94771
UT 8800	800	94770

Chipboard shelves, recessed

19 mm thick. Used as a stop, inserted into the longitudinal beams.

The beams are not included in the scope of delivery, please order separately (page A18).

Item	shelf depth (mm)	W x D x H (mm)	Order no.
for bay width 994 mm			
KRAB 341020	400	985 x 355 x 19	6670438
KRAB 351020	500	985 x 455 x 19	6670425
KRAB 361020	600	985 x 555 x 19	6670439
KRAB 381020	800	985 x 755 x 19	6670441
for bay width 1,282 mm			
KRAB 341320	400	1,273 x 355 x 19	6670424
KRAB 351320	500	1,273 x 455 x 19	6670426
KRAB 361320	600	1,273 x 555 x 19	6670440
KRAB 381320	800	1,273 x 755 x 19	6670442

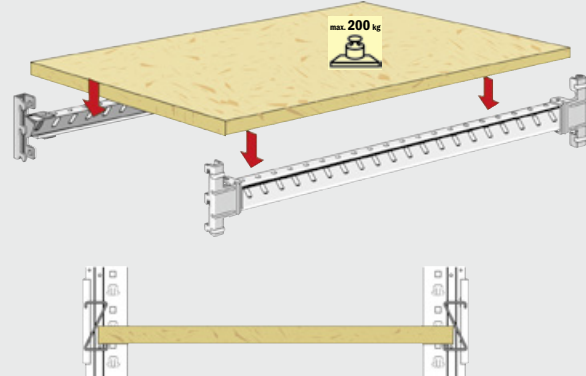

Sheet steel panels

Galvanized, single or multiple panels can be used to create closed storage areas on the beam levels. W 328 x D 800 mm.

The beams are not included in the scope of delivery, please order separately (page A18).

Item	for bay width (mm)	Order no.
PA7834	994 (3 x for bay 994 mm)	29110

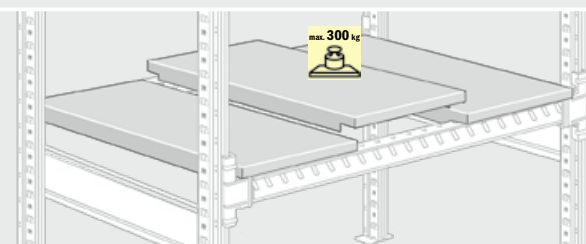

Universal set

The universal set allows the distances between the individual beams to be configured independently on the rack depth. Two opposite TA 4800 beam supports are fitted onto the upright lugs on the sides at the same height. These beam supports have vertical slits. The universal beams fit into the slots and any number can be attached with freely configurable spacings. The entire system is supplied as one universal set, consisting of 2 galvanized TA beam supports and 2 galvanized UT universal beams.

Item	Designation	Order no.
US 4100	Universal set, 4-piece, shelf depth 800 mm	26700
UT 4114	Universal beams, single	26710
KRT 4100	Terodaem underlay, self-adhesive	28220

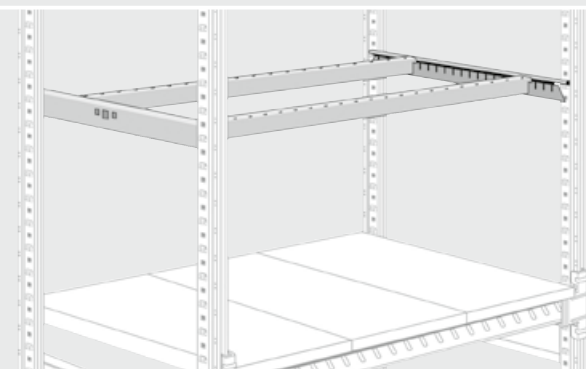



LIGHT SILVER



Ornamental parts mesh

GALVANIZED



Long parts hook

Panel and long material storage

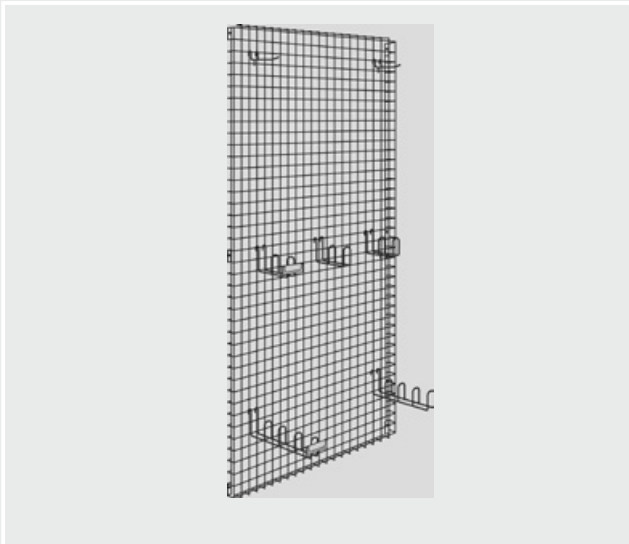

Mesh wall hanging racks

Made of structural steel mesh, 50 x 50 x 4 mm, painted light silver. Incl. fastening clips.

Item	W x H (mm)	Order no.
ZR 210/W	1,055 x 2,050	11380

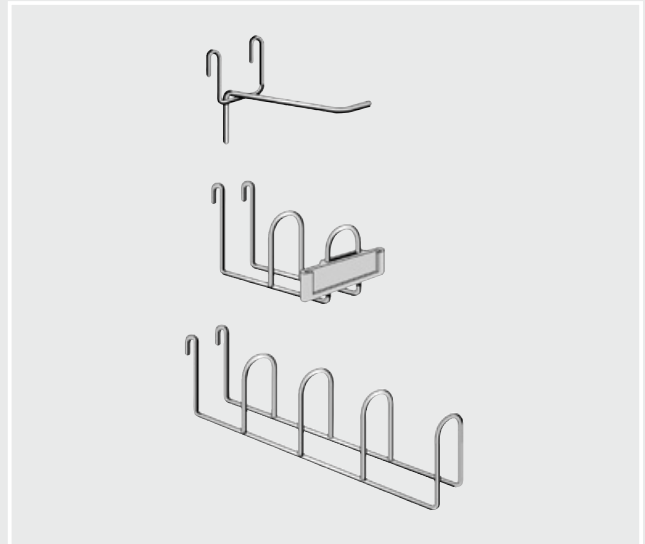

Long parts hook

Galvanized steel wire. Hook for storing long parts and ornamental parts, hooked into the wire-mesh wall racks.

Item	Depth (mm)	Height (mm)	Type	Order no.
ZH 1	100	75	single	11600
ZH 2	160	75	2 center bars	11390
ZH 4	350	75	4 center bars	11410



Label holder, labels and protective films

Item	Type	L x W (mm)	PU	Order no.
ZE 82	Plastic label frame	85 x 20	1	11420
ZEE	Index cards for ZE 82		100	11930
ZEF	Protective film		100	11940



For more information about panel and long material storage

on request

Water permeable shelves, shelving for the hazardous goods in storage

i Project-specific solutions
 We implement requirements regarding water and/or light permeability for your project with either perforated or wire mesh shelves.
 Talk to us!

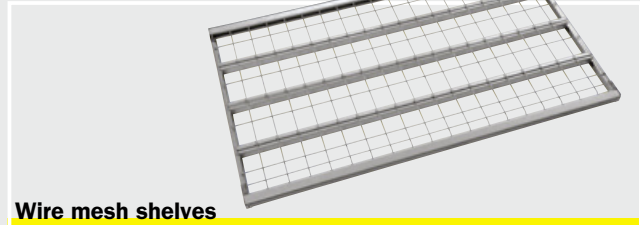

Wire mesh shelves

Edge and reinforcements made of galvanized sheet steel with inserted wire-mesh. Load-bearing capacity up to max. 250 kg. Water permeability of up to 70%, ideal for project-specific fire protection requirements. Ideal for well-lit working environments and good air circulation. Powder-coated version on request.

Item	Shelf depth (mm)	L x D x H (mm)	Load (kg)	Order no.
DGB 341010 V	400	994 x 400 x 30	100	51701
DGB 341020 V	400	994 x 400 x 30	200	51706
DGB 351010 V	500	994 x 500 x 30	100	51702
DGB 351020 V	500	994 x 500 x 30	200	51707
DGB 361010 V	600	994 x 600 x 30	100	51703
DGB 361020 V	600	994 x 600 x 30	200	51708
DGB 381020 V	800	994 x 800 x 30	200	51709
DGB 341315 V	400	1,282 x 400 x 30	150	51711
DGB 341325 V	400	1,282 x 400 x 30	250	51716
DGB 351315 V	500	1,282 x 500 x 30	150	51712
DGB 351325 V	500	1,282 x 500 x 30	250	51717
DGB 361315 V	600	1,282 x 600 x 30	150	51713
DGB 361325 V	600	1,282 x 600 x 30	250	51718
DGB 381325 V	800	1,282 x 800 x 30	250	51719



Hazardous materials storage system

Shelving with drip trays and grating shelves for the storage of water-polluting substances as per WHG and combustible materials as per the Ordinance on Industrial Safety and Health (BetrSichV) along with substances of positive liquid list as per DIN 6601. The hazardous goods rack can only be equipped with grated shelves and drip trays. Other accessories from the R 3000 system cannot be used.

The drip tray is attached securely to the lowest shelf level, installed in accordance with the following testing principles:

- Construction rules list A, Part 1, serial no. 15.22, edition 2002/2 from the German Institute for Building Technology
- Ordinance on Installations for the Handling of Substances Hazardous to Water (VAWS)
- Water Resources Act (WHG) section 19h in combination with the Ordinance on Installations for the Handling of Substances Hazardous to Water (VAWS)
- Directive regarding the Requirements for Collecting Trays made of Steel (StawaR)
- DIN 6600, DIN 6601, DIN 6625

Above-ground collecting trays made of sheet steel S350GD+Z, liquid-tight welded, suitable for materials with a density of max. 1,000 kg/m³. A corresponding test certificate from RWT has been issued. Compliance with the guidelines is documented by the identification plate on the tray and the corresponding declaration of conformity.

Grating shelves

Item	Shelf depth (mm)	L x D x H (mm)	Load (kg)	Order no.
G 4400	400	993 x 345 x 30	200	98190
G 4500	500	993 x 445 x 30	200	98170
G 4600	600	993 x 545 x 30	200	98180
G 4800	800	993 x 745 x 30	200	97980

Drip trays

Item	Shelf depth (mm)	L x D x H (mm)	Collection vol. (l)	Order no.
OAW 4400	400	1,020/970 x 390 x 120/127	30	97990
OAW 4500	500	1,020/970 x 490 x 120/127	38	98150
OAW 4600	600	1,020/970 x 590 x 120/127	46	98160
OAW 4800	800	1,020/970 x 790 x 120/127	60	97970

Order no. = on stock

Modular shelving

Longspan racking

Pallet racking

Cantilever racking

On-line shelving/ KDR shelving

Customer Service & Support